

**ARINI**  
**INSPIRED BY NATURE**

INFO DATA SHEET



## ARINI – INSPIRED BY NATURE

### Light, multifunction, design – and inspired by nature

Light, multifunction and design: Three elements that we have combined in a unique lighting system – and which were inspired by nature.

A lighting system based on the organic forms of nature. And a lighting system, for which we have let ourselves be inspired by the diversity and impressions of nature.

With its flowing curves, the ARINI appears as a harmonious portraiture of a stylized parrot sitting in a tree. A portraiture that is internally harmonious and that unites the natural with the urban.

**ARINI** – For the urban jungle of today and tomorrow



## ARINI – LIGHT

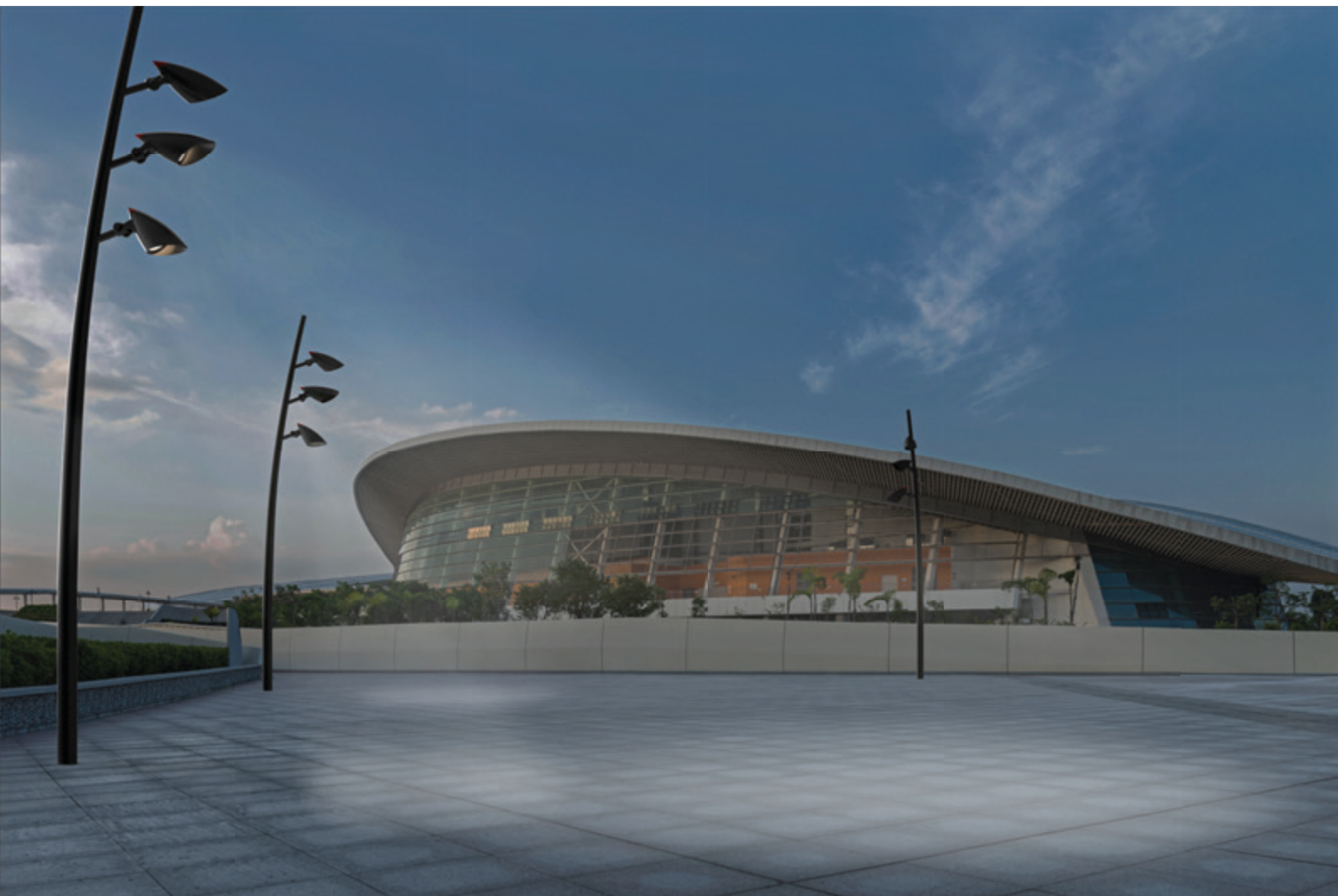

### Perfect light – versatile design with light

Lend urban spaces and squares their own character in the dark and transform these into meeting places or places of encounter – full of atmosphere and emotion as well.

#### Rotationally symmetric:

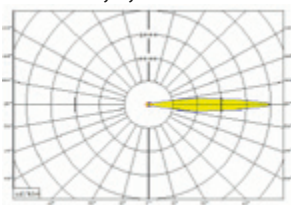

SPOT: 10°

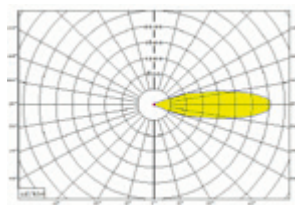

MID: 25°

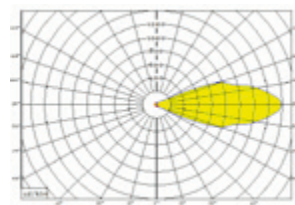

WIDE: 60° \*

#### Axially symmetric:

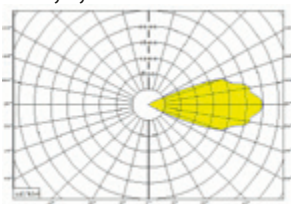

25° x 60° \*

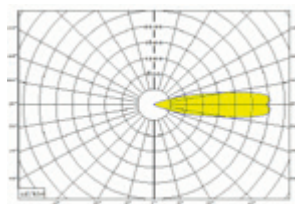

60° x 25° \*

### Optical systems

ARINI can be fitted with five different optical systems. You can always choose the best solution for your idea.

\* Note regarding light distribution:

Optic	Light distribution (due to shroud)
60° rotationally symmetric	45° rotationally symmetric
25° x 60° axially symmetric	25° x 45° axially symmetric
60° x 25° axially symmetric	45° x 25° axially symmetric



## ARINI – MULTIFUNCTION



### More than light – intelligent due to multifunction

Highly-specialized and multifunctional. ARINI unites both perfectly.

Nature demonstrates that versatility represents an elementary attribute. And parrots are famous for the fact that they are extraordinarily communicative and enjoy being in the company of their own species.

The ARINI is versatile – and even more than that.

The ARINI, with its multifunctionality, stands for a modern togetherness and ensures that urban spaces become attractive meeting places and walkways and squares become safe and communicative areas.





## ARINI – MULTIFUNCTION SPEAKER AND HIFI-SPEAKER

For the urban jungle of today and tomorrow, we have developed ARINI knowingly with a high degree of multifunctionality. As part of this multifunctionality, information and entertainment, ARINI speaker and ARINI HIFI Speaker represent a key component.

Meeting your exact needs, you can choose between a pressure chamber loudspeaker (SPEAKER) or a HIFI loudspeaker (HIFI SPEAKER).

### SPEAKER

The included pressure chamber loudspeaker is perfectly suitable for all areas in which regular announcements are necessary. Despite its compact construction, a great power capacity is reached, which enables a high penetration – especially at high noise levels, e.g. at train stations and in or around stadiums.

A highpass filter for sound and stability optimisation is integrated in the pressure chamber loudspeaker so that simple sonication with music is also possible.

### HIFI-SPEAKER

The HIFI SPEAKER is also perfectly integrated in ARINI. With its two-way system it provides a high sound quality and ensures an audible improved listening experience. The HIFI SPEAKER is first choice with its low- and high-frequency transducers as a public address system for music in the open space.

**The ARINI SPEAKER: Communication, information and entertainment.**

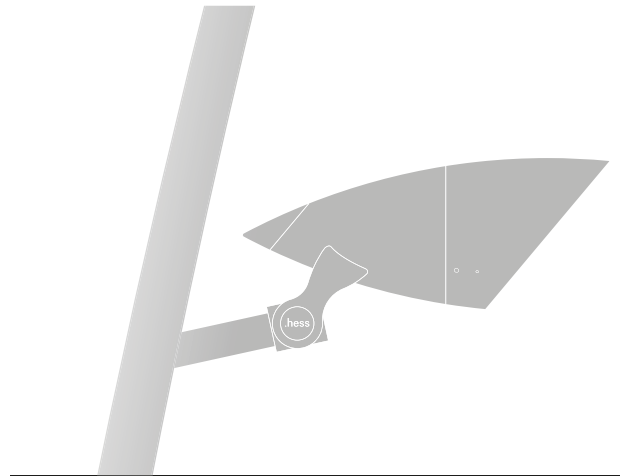

## SPEAKER

### Technical Information

Power rating	25/12,5/6,25 W <sub>RMS</sub>
Frequency range	500 - 13000 Hz
Mean sound pressure	107 dB
Beam angle (hor./vert.)	90°/90°
Operating Temperature	-20° C° up to +50° C°
Dimensions	ø 130 mm x 175 mm
Weight	1,8 kg
Protection rating	IP 64

## HIFI-SPEAKER

### Technical Information

Power rating	25 W <sub>RMS</sub>
Frequency range	95 - 20000 Hz
Mean sound pressure	90 dB
Impedance	8 Ω
Operating Temperature	-25° C° up to +45° C°
Dimensions	ø 164 mm
Weight	0,8 kg
Protection rating	IP 44



## ARINI – MULTIFUNCTION WiFi

For the jungles that constitute today’s urban centres, we designed ARINI, endowing it with a high degree of multifunctionality. Wi-Fi is an essential module in the product’s multifunctional repertoire.

The ARINI Wi-Fi provides broad connectivity and integrates seamlessly in ARINI’s elegant design. As a result, the luminaire remains at harmony with its settings, integrating the natural world with the urban world.

Your flexibility was a key objective in our design of the Wi-Fi module, leading us to choose standard components. Thus, other Wi-Fi components and options are available to you, such as additional antennas and access points in diverse locations, including building walls, allowing you to integrate into existing systems or create integral networks. Range expansion for extended Wi-Fi coverage is easy to realise. Here as well ARINI blends harmoniously into its surroundings – aesthetically and technically.

### HIGH POWER – WIDE COVERAGE

Featuring the world’s smallest and most powerful WAP station, ARINI creates a robust and wide-coverage Internet point, thanks to its high performance technology.

Ideal for versatile outdoor applications, the internet device reaches the broadband speed of 100+ Mbps and covers up to a 200 m range, connecting multiple wireless users in the area.

### LEADING-EDGE TECHNOLOGY

The Time Division Multiple Access (TDMA) technology allocates each user to pre-designated time slots through an intelligent AP controller. This system improves multi-user connection performance, in terms of efficiency, responsiveness and scalability. The result is a highly reliable, high-speed carrier grade network.

A smart QoS device shapes the traffic of data, giving priority to voice and video elements to ensure a seamless navigation experience for all of its users by eliminating hidden node collisions.

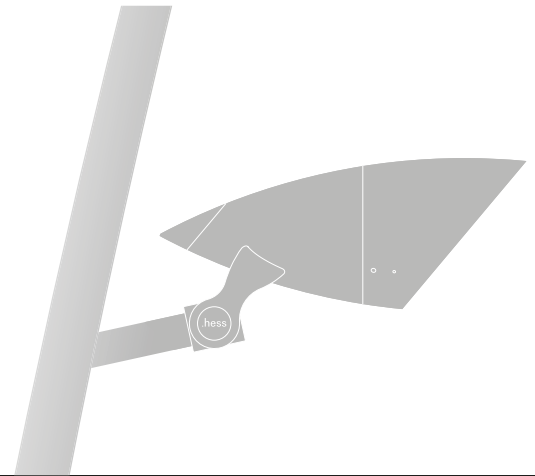

### System Information

Processor Specifications	Atheros MPIS 24KC, 400 MHz
Memory	32 MB SDRAM, 8 MB Flash
Networking Interface	(1) 10/100 Ethernet Point

### Regulatory/Compliance Information

Wireless Approvals	FCC Part 15.247, IC RS210, CE
RoHS Compliance	Yes

### Physical/Electrical/Environmental Information

Antenna	(1) External, 2 dBi Omni Antenna
Operating Frequency	2412-2462 MHz
Range (Outdoor)	Up to 200 m
Max. Power Consumption	8 W
Power Supply (PoE)	15V, 0.8A Power Adapter
Power Method	Passive Power over Ethernet (Pairs 4, 5+; 7, 8 Return)
Operating Temperature	-20 to 70° C
Operating Humidity	5 to 95% Condensing

### Output Power

2.4 GHz TX POWER SPECIFICATIONS			2.4 GHz RX POWER SPECIFICATIONS				
	Data Rate / MCS	Avg. TX	Tolerance		Data Rate / MCS	Sensitivity	Tolerance
11 b/g	1-24 Mbps	28 dBm	± 2 dB	11 b/g	1-24 Mbps	-97 dBm	± 2 dB
	36 Mbps	27 dBm	± 2 dB		36 Mbps	-80 dBm	± 2 dB
	48 Mbps	26 dBm	± 2 dB		48 Mbps	-77 dBm	± 2 dB
	54 Mbps	24 dBm	± 2 dB		54 Mbps	-75 dBm	± 2 dB

## ARINI – MULTIFUNCTION CCTV

ARINI possesses all the multifunctional qualities required to flourish in big city jungles and modern smart cities. And where security is important, it excels. ARINI's CCTV module features a camera so perfectly integrated into its housing that nothing escapes its view – wherever you want it to: Whether public spaces or in the industrial as well as private sector. ARINI's pole accommodates up to 5 ARINI CCTV units and allows their positioning, as you require.

ARINI – Versatility for your needs, especially security.

### DEPENDABLE, SECURE, RUGGED AND EASY

When it comes to security, we make no compromise. With ARINI, neither do you. We engineered ARINI's housing and camera specifically for ruggedness and configured it with the highest quality technical components. External influences, such as vibration, temperature fluctuation, moisture (IP66), dust and dirt roll off its resistant construction, ensuring you'll have an unwavering, reliable video signal always.

In the event of an attempt to tamper with or damage the camera wilfully, whether spray paint or violence, an integral manipulation detector and transponder alert specified receivers, such as security personnel. The unit connects and installs with ease, requiring only a network cable, and for electricity either a power line or Ethernet (PoE).

The camera has an on-board memory and an integral port, the latter permitting the transfer of data to a flash card (MicroSD / SDHC / SDXC).

When light is minimum and in darkness, the camera employs Wide Dynamic Range Technology (WDR Pro), to ensure the high quality capture and imaging necessary for identification. In addition, the unit features 3D noise reduction, which keeps sensor noise at a minimum for improved image quality in challenging light.

### Features:

- 1.2-Megapixel CMOS Sensor
- EN50155 Compliance for Professional Mobile Surveillance
- Vandal-proof IK10-rated and Weather-proof IP66-rated Housing
- Built-in 802.3af Compliant PoE
- Built-in MicroSD/SDHC/SDXC Card Slot for On-board Storage
- Video Rotation for Corridor Scenario

### Alarm events:

- Video motion detection
- Manual trigger
- Digital input
- Periodical trigger
- System boot
- Recording notification
- Camera tampering detection
- Temperature detection
- Audio detection

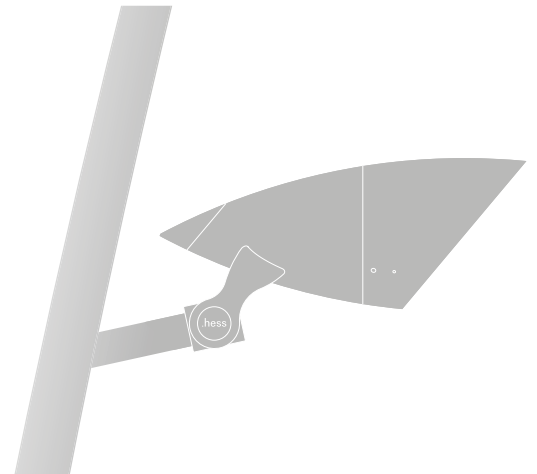

### Camera Features

Lens Type	Fixed-focal
Focal Length	3.6 mm
Aperture	F1.8
Field of View	80° (hor) / 57° (ver) / 103° (dia)
Shutter Time	1/5 sec. to 1/32,000 sec.
Minimum Illumination	0.4 Lux @ F1.8, 30 IRE (Color)

### Video

Compression	H.264, MPEG-4 & MJPEG
Maximum Frame Rate	H.264 / MPEG-4 / MJPEG: <ul style="list-style-type: none"> <li>• 30fps @ 1280x960</li> <li>• 30fps @ 960x1280</li> </ul>
Maximum Streams	4 simultaneous streams

### General

Casing	Weather-proof IP66-rated Vandal-proof IK-10 rated
Safety Certifications	CE, LVD, FCC Class A, VCCI, C-Tick EN50155



## ARINI – MULTIFUNCTION GOBO

With its multifunctional characteristics, ARINI is ideally positioned to meet the demands of the urban jungle. ARINI GOBO is the perfect tool for creating additional highlights in cities in front of prestigious buildings, shopping centres and company premises. A projector integrated in the ARINI housing, with individually designed Gobos, ensures that you always have an eye-catcher on display wherever you want it: Whether on façades, as a design element or as a waymarker on the ground,

you will impress customers and visitors alike with the ARINI GOBO.

The air-cooled, 40-watt, high-powered LEDs from PHOS 45 outdoor, offer increased performance. The projector is suitable for outdoor use year-round. The lens is equipped with a special seal that prevents the ingress of moisture. All electronic components are encapsulated to be watertight. The recommended (static) projection distance for the 40-watt, high-powered LEDs at dusk and at night, is 10 metres. The projector is ideally suited for projections up to a diameter of approx. 4 metres on façades or portals and for projecting eye-catching information on pavements or in pedestrian zones. The projection motif (Gobo) can be changed easily without any tools.

### Equipment:

Available off the shelf, with high-powered LEDs and standard 85 mm lens.

### Required accessories:

Glass Gobo (not included in scope of delivery) with individual motif, can be ordered from: [www.derksen.de](http://www.derksen.de)

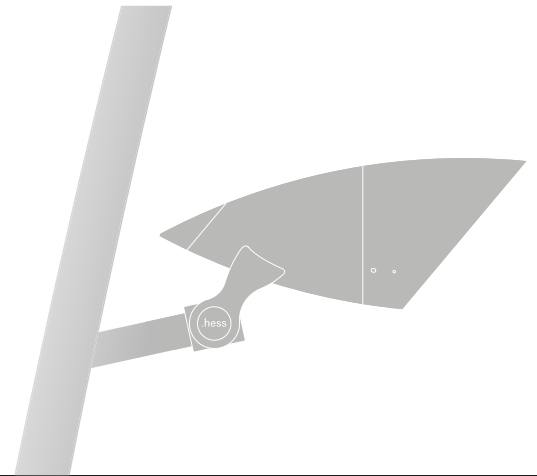

### General technical information

GOBO sizeø	50 mm
IMAGE size ø	40 mm
Projection distance in the dark	10.000 mm
Protection rating	I
Ingress protection of the housing	IP 64
Ambient temperature	-30° C to + 35° C
Cooling	activ, fan
Noise level	33 dBA
Input voltage	100 - 240 AC, 50/60Hz

### Technical lighting specifications

Colour temperatur	6.300 - 6.700 K
Luminous flux of the LEDs	2.700 lm
Power usage	51W
Lifetime of LEDs (L70)	35.000 h
Efficiency	0,5 cos φ

### Safety information

Photobiological safety as per IEC62471:2006 EN62471:2008	RG-2
--	------



## ARINI – DESIGN



### **Design – drawn by nature**

The flowing and soft contours of ARINI are drawn by nature – in this way, the harmonious and consistent line contour of the parrot are found again in ARINI. Even the choice of name was influenced by nature.

ARINI – as shapely and colourful as the model that inspired it

Organic design and bright colours. With ARINI, you set real spots of colour in the urban jungle – at night and during the day. At the same time, due to its characteristics, ARINI literally brings light as well as multifunction and design into the city's undergrowth.

Furthermore, urban spaces can be organised and structured clearer – and as a result, become more usable and more liveable.



## ARINI – DESIGN



### ARINI TREE

With its flowing curves, the ARINI comes across as a harmonious portrait of a parrot sitting in a stylised tree.

When developing the ARINI TREE, we used this stylised tree with parrots sitting in it as our inspiration. The result is an extraordinary eye-catcher for public urban spaces and for corporate and administrative locations.

The six-metre-tall ARINI TREE is fitted with a total of 12 ARINI heads, which can be equipped with a wide variety of functions, including lights, WLAN, loudspeakers, or cameras – entirely according to your wishes and requirements.

The ARINI TREE – a gem that sets accents by day and night and attracts attention wherever it is installed.





ARINI – DESIGN



## ARINI – TECHNICAL DATA LUMINAIRE



### ARINI Light

- Luminaire head and shield made from die cast aluminium
- End cap made from PC, painted
- Hinge for horizontal (max. 120°) and vertical (max. 130°) adjustment
- 360° adjustment of shield possible
- Luminaire cover made from PMMA
- Elec. equip. with LED module, light colours optionally 3000K / 4000K
- System power approx. 54W
- \* Choice of optics 10° / 25° / 60° rotationally symmetric or 25° x 60° axially symmetric / 60° x 25° axially symmetric
- Ingress protection IP 66
- Protection Rating optionally I / II
- Colour: RAL (classic-unicolour) / HESS-DB+Glimmer (to be specified). RAL Pearl-Metallic on request
- Connection: Pre-wired, 10000mm, 3 x 1,0 mm<sup>2</sup>
- Weight: approx. 10 kg

### ARINI Light +

- Luminaire head and shroud made from die cast aluminium
- End cap made from PC, inside partially satined, outside polished
- Hinge for horizontal (max. 120°) and vertical (max. 130°) adjustment
- 360° adjustment of shield possible
- Luminaire cover made from PMMA
- Elec. equip. with LED module, light colours optionally 3000K / 4000K
- End cap illuminated with RGBW LED unit
- Control and dimming optionally via DALI or DMX or CASAMBI
- System power approx. 60W
- \* Choice of optics 10° / 25° / 60° rotationally symmetric or 25° x 60° axially symmetric / 60° x 25° axially symmetric
- Ingress protection IP 66
- Protection Rating optionally I / II
- Colour: RAL (classic-unicolour) / HESS-DB+Glimmer (to be specified). RAL Pearl-Metallic on request
- Connection: Pre-wired, 10000mm  
DMX: 3 x 1,0 mm<sup>2</sup> (power) and additional network cable  
DALI: 5 x 1,0 mm<sup>2</sup> (power)
- Weight: approx. 10 kg

### \* Note regarding light distribution:

Optic	Light distribution (due to shroud)
60° rotationally symmetric	45° rotationally symmetric
25° x 60° axially symmetric	25° x 45° axially symmetric
60° x 25° axially symmetric	45° x 25° axially symmetric

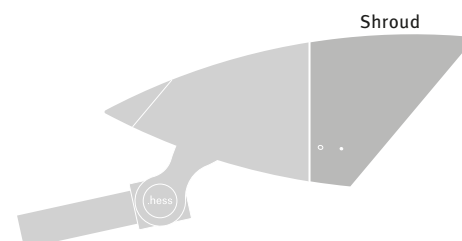



## ARINI – TECHNICAL DATA POLE



### ARINI G

- Steel pole, galvanised inside and outside
- Conical design
- Curved
- Height from ground level optionally 5200 / 7000 / 9000 mm
- Pole Ø at the bottom 122 / 168 / 196 mm
- Embedded base with 2 openings for cable entry, optionally with square flange plate
- Separate embedded base on request
- With inspection-door and C-rail for fuse-box
- When equipped with ARINI light +, additional junction box for wiring of control leads
- Number of luminaires:  
ARINI G 5200: 1 / 2  
ARINI G 7000/9000: 3 / 4 / 5
- Arrangement of luminaire heads either single-sided, two-sided (180° shifted) or in 360° design
- Colour: RAL (classic-unicolour) / HESS-DB+Glimmer (to be specified). RAL Pearl-Metallic on request

### ARINI N 0°

- Steel pole, galvanised inside and outside
- Conical design
- Height from ground level optionally 5200 / 7700 / 10700 mm
- Pole Ø at the bottom 121 / 174 / 216 mm
- Optionally straight (0°) or inclined (4°)
- With top peak
- Pole N 0° with embedded base with 2 openings for cable entry, optionally with square flange plate
- Pole N 4° with square flange plate
- Separate embedded base on request
- With inspection-door and C-rail for fuse-box
- When equipped with ARINI light +, additional junction box for wiring of control leads
- Number of luminaires:  
ARINI N 5200: 1 / 2  
ARINI N 7700/10700: 3 / 4 / 5
- Arrangement of luminaire heads either single-sided, two-sided (180° shifted) or in 360° design
- Colour: RAL (classic-unicolour) / HESS-DB+Glimmer (to be specified). RAL Pearl-Metallic on request

### ARINI N 4°

## ARINI – TECHNICAL DATA WALL BRACKET

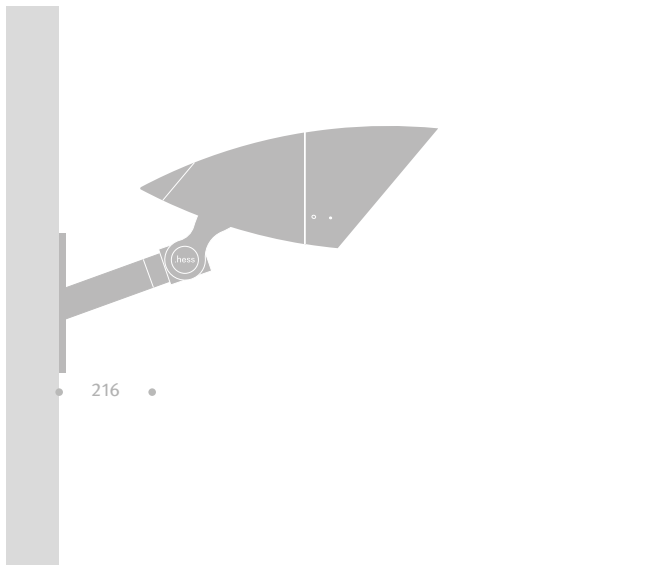

### ARINI Wall bracket

- For versions: Light, Light + (DALI), Speaker, HIFI-Speaker
- Made of galvanised steel
- Length: 206 mm, incl. mounting plate 216mm
- Mounting plate dimensions: H200mm x B160mm
- Mounting material for wall fixation on site
- Colour: RAL (classic-unicolour) / HESS-DB+Glimmer (to be specified). - RAL Pearl-Metallic - only on request

## ARINI – OVERVIEW STANDARD CONFIGURATIONS

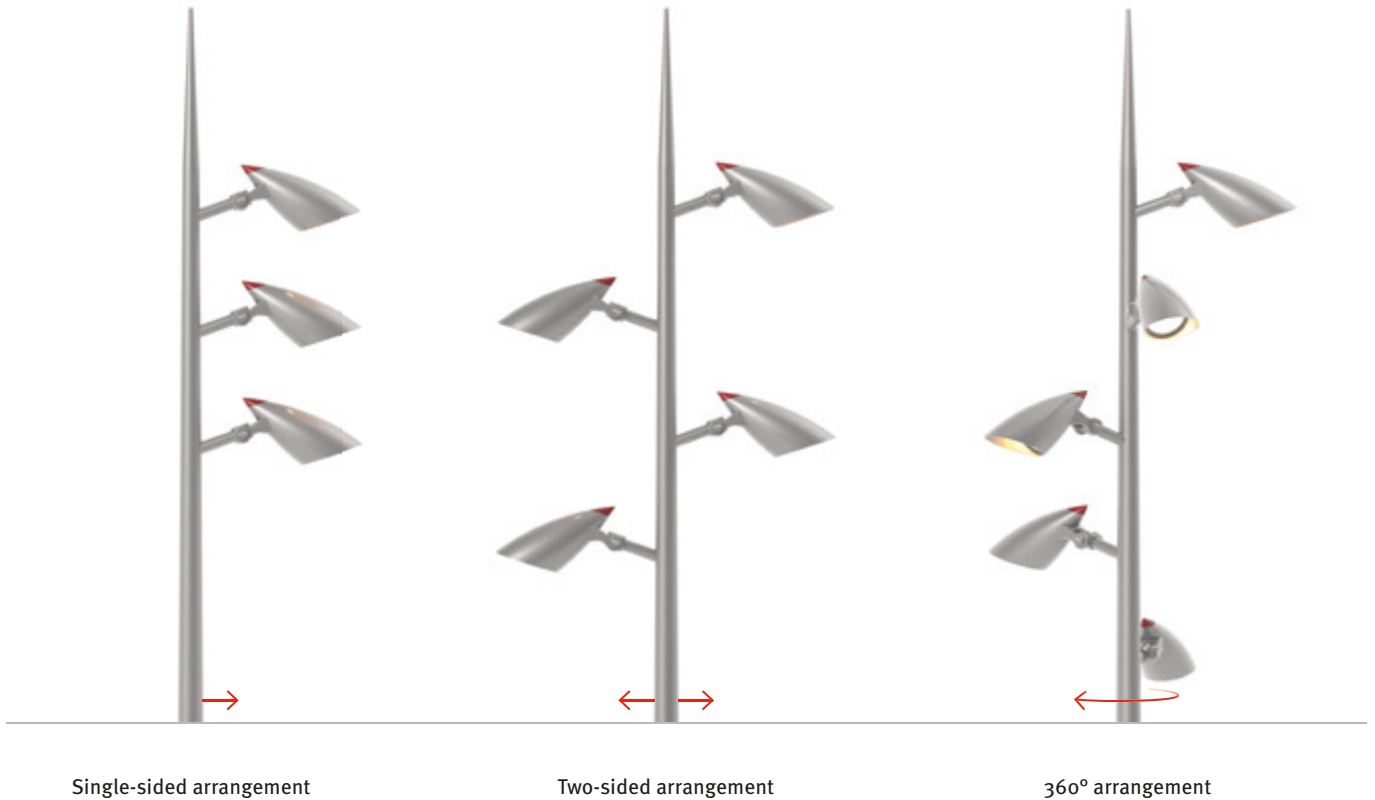

Product	Height	Number of luminaires		
		Single-sided arrangement	Two-sided arrangement	360° arrangement
ARINI G	5200 mm	1   2	2	-
ARINI G	7000 mm	3   4   5	3   4   5	3   4   5
ARINI G	9000 mm	3   4   5	3   4   5	3   4   5
ARINI N 0°	5200 mm	1   2	2	-
ARINI N 0°	7700 mm	3   4   5	3   4   5	3   4   5
ARINI N 0°	10700 mm	3   4   5	3   4   5	3   4   5
ARINI N 4°	5200 mm	1   2	2	-
ARINI N 4°	7700 mm	3   4   5	3   4   5	3   4   5
ARINI N 4°	10700 mm	3   4   5	3   4   5	3   4   5

## ARINI – DIMENSIONS (luminaire head in mm)

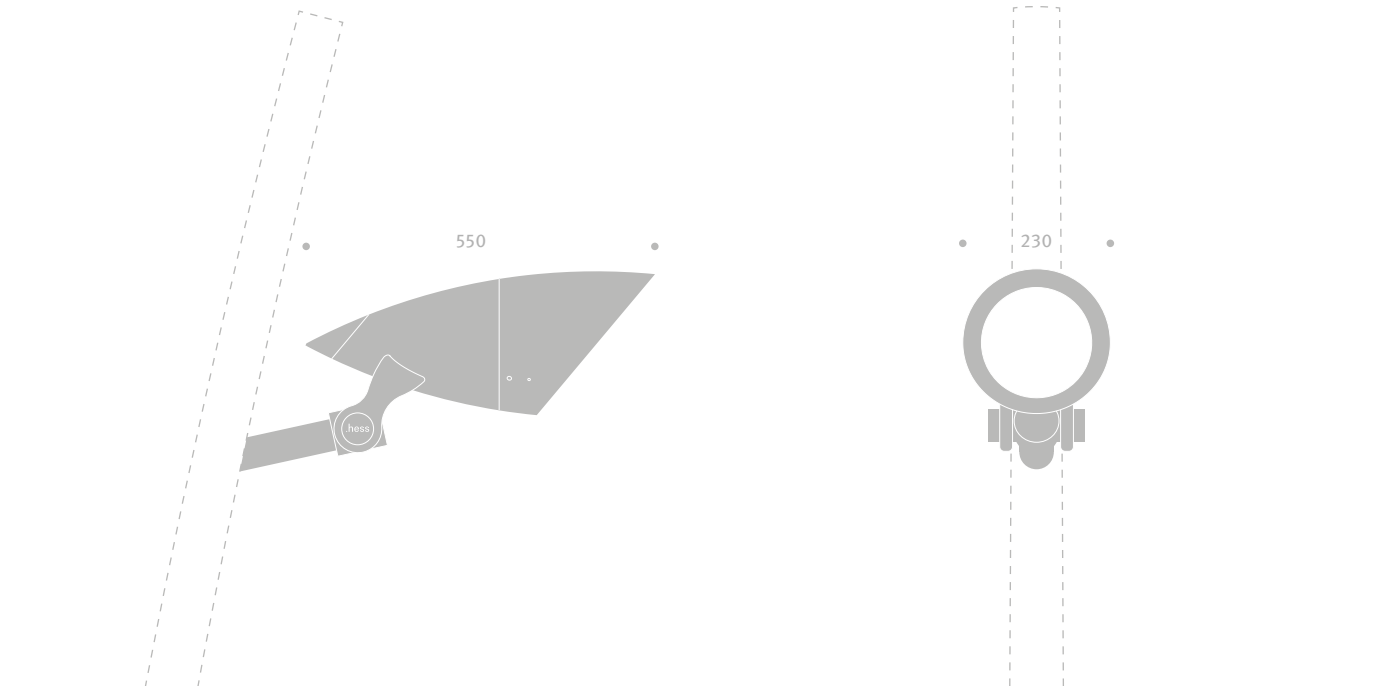

## ARINI – ADJUSTMENT LUMINAIRE (horizontal)

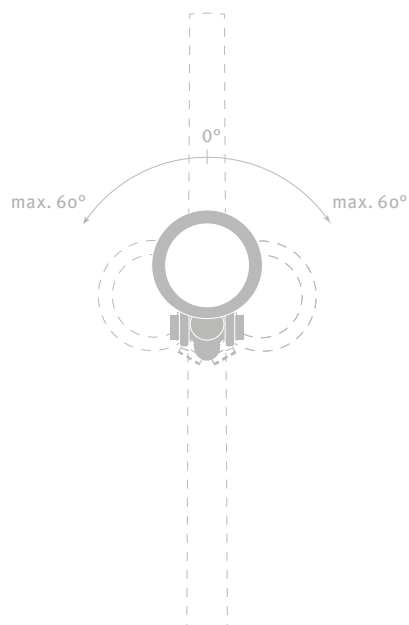



## ARINI – INCLINATION LUMINAIRE (vertical)

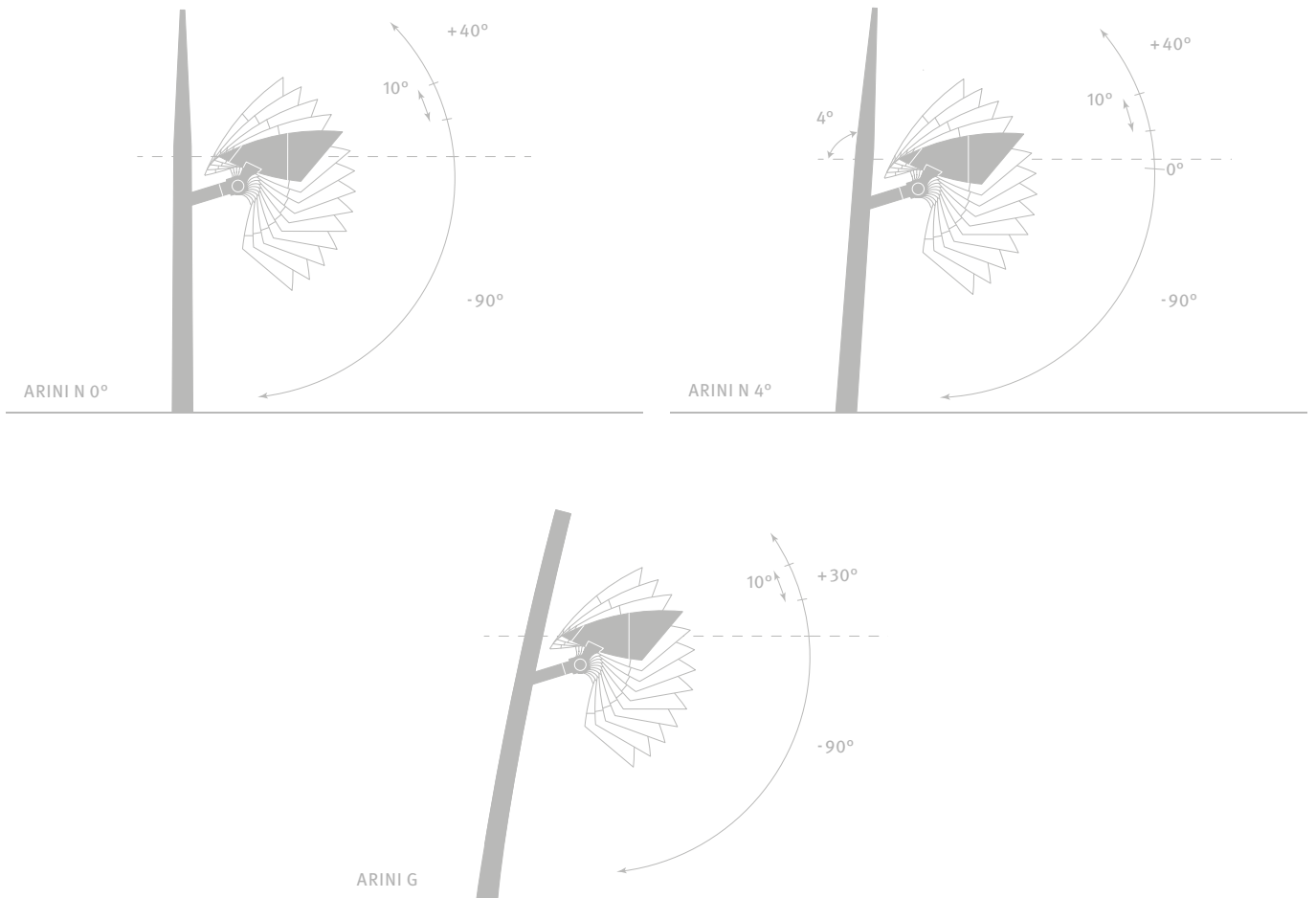

## ARINI – MEASUREMENTS (System in mm)

### ARINI G

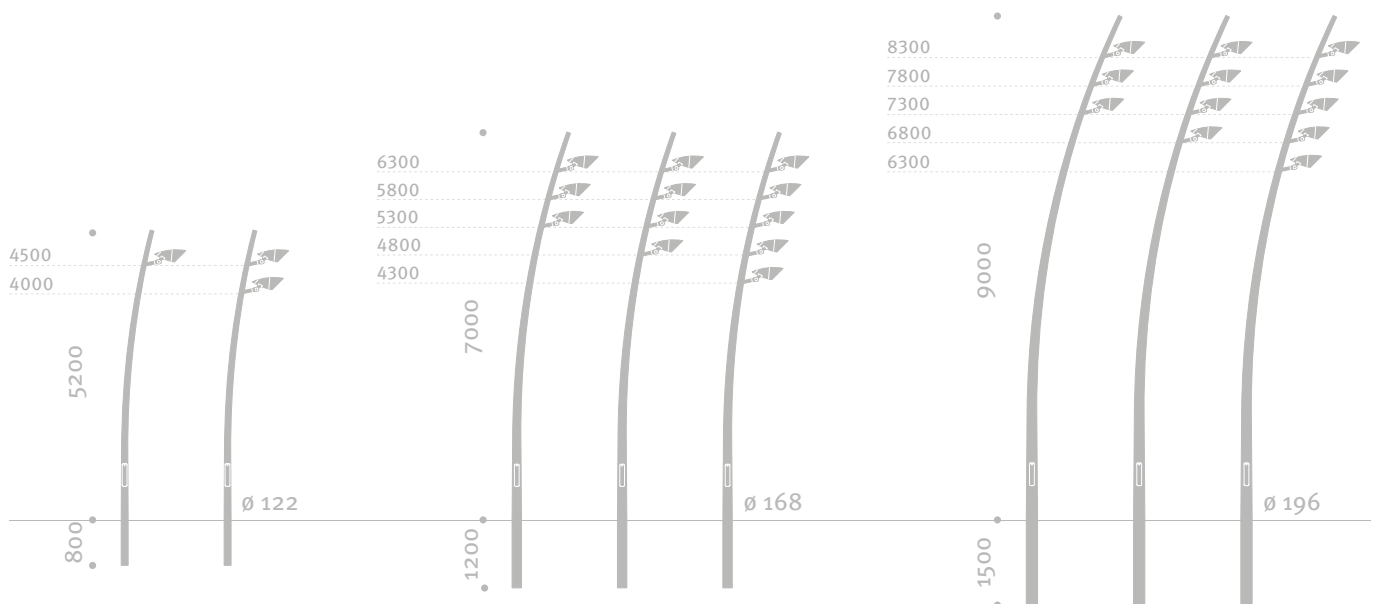

## ARINI – MEASUREMENTS (System in mm)

### ARINI N 0°

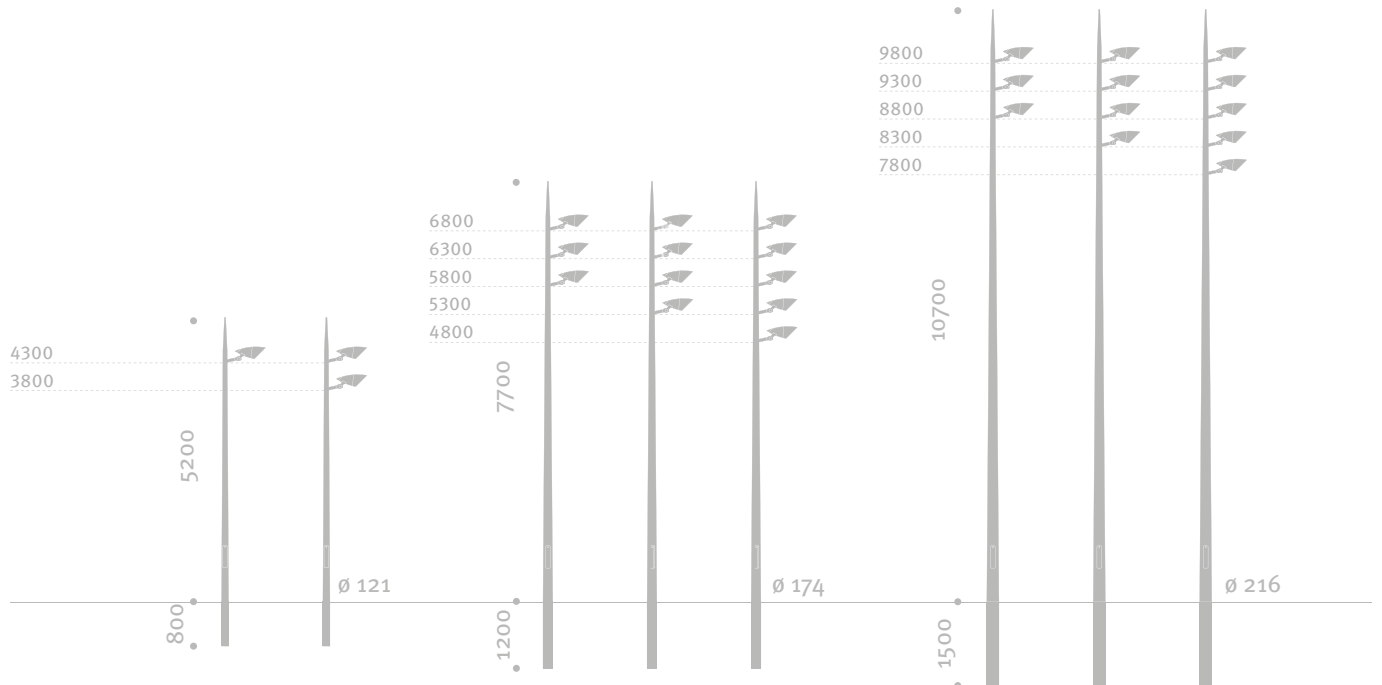

### ARINI N 4°

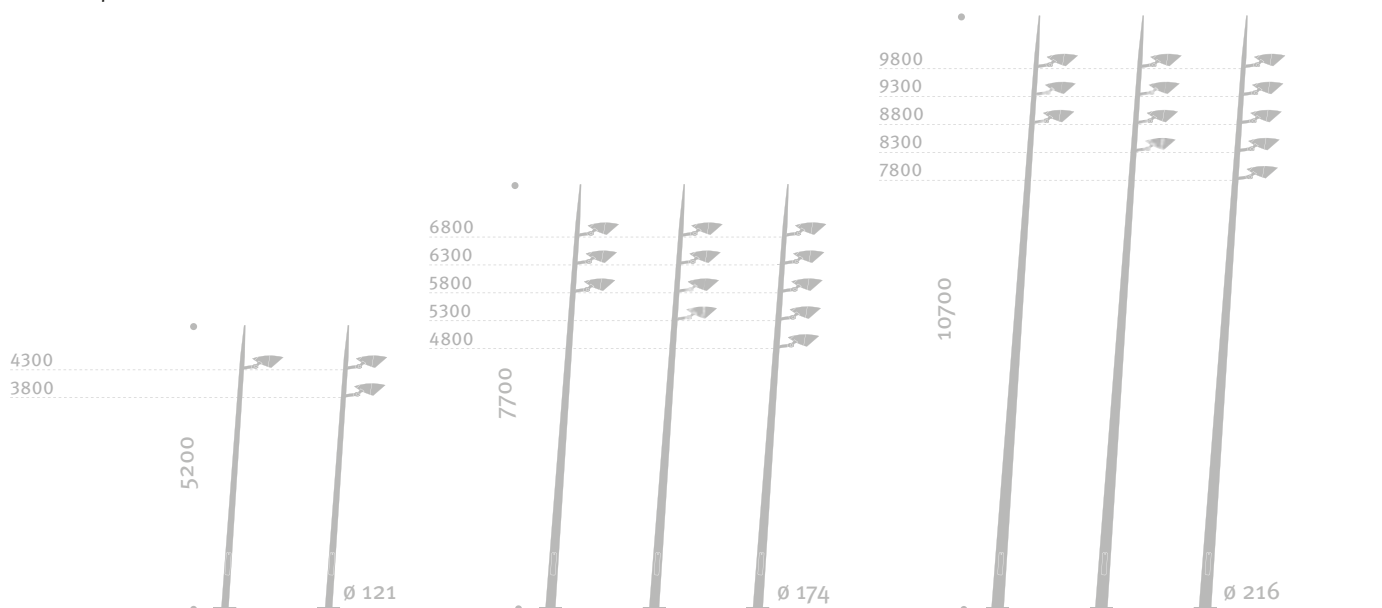

## ARINI – ALSO ONLINE

### Homepage



[hess.eu/en/arini](https://www.hess.eu/en/arini)

### Brochure



[https://www.hess.eu/fileadmin/user\\_upload/Downloads/Hess\\_Broschueren/Hess\\_ARINI\\_EN.pdf](https://www.hess.eu/fileadmin/user_upload/Downloads/Hess_Broschueren/Hess_ARINI_EN.pdf)



### Mood Finder

ARINI is also available online.

Immerse yourself in the fascinating world of ARINI with our Mood Finder. Experience light, multifunction and design in a new way.



[arini.hess.eu](https://arini.hess.eu)

